

CLIP ON SEAL

Clip on pinch weld is made of EPDM rubber and steel core for maximum strength. Top/side bumper is made of waterproof EPDM sponge. For use any sort of automobile.

SOLD BY THE ROLL OR IN INCREMENTS OF 1M. STANDARD COIL LENGTH 25M OR 50M.
 PICTURES ARE INDICATIVE ONLY, NOT TO SCALE.

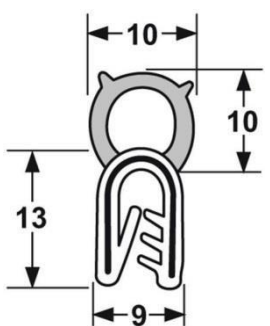

10x10mm Boot
60-051SCH

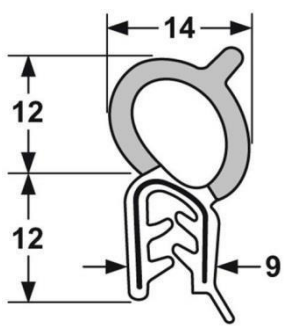

12x14mm Boot
66-010

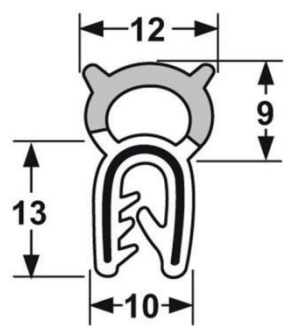

13x12mm Boot
66-057

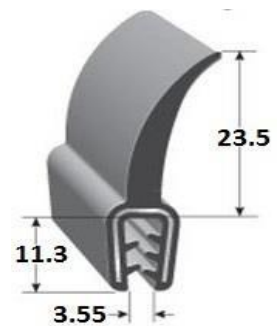

Ute Seal
DD1201

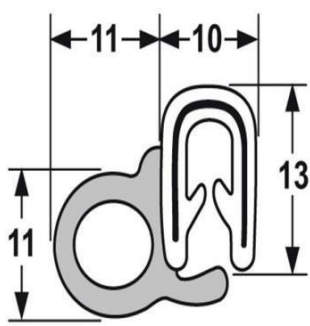

11x11mm Door
66-040

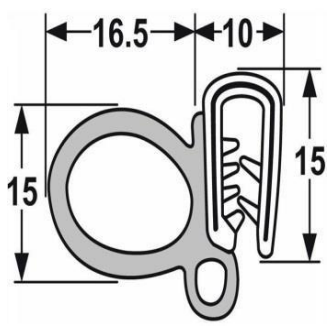

15x16.5mm Door
60-054

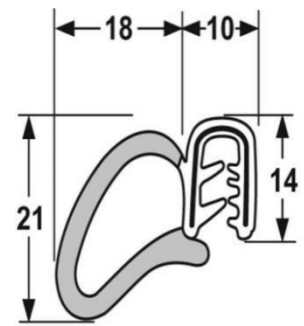

21x18mm Door
66-013

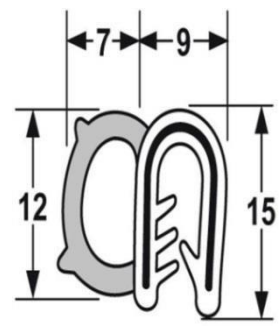

12x7mm Door
60-053SCH

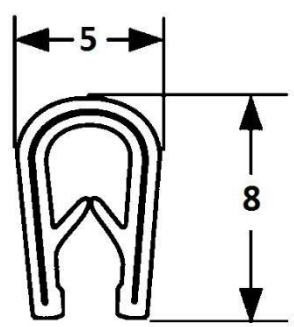

Trim
66-059

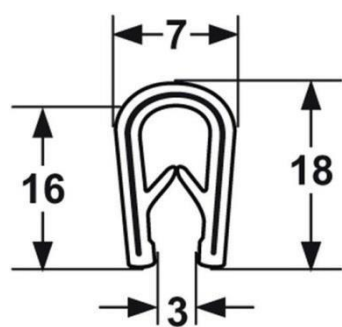

Trim
66-8295

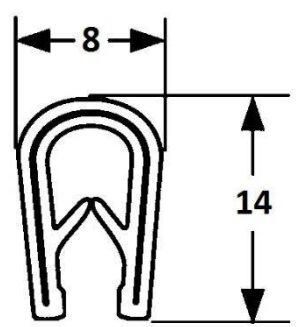

Trim
60-056B

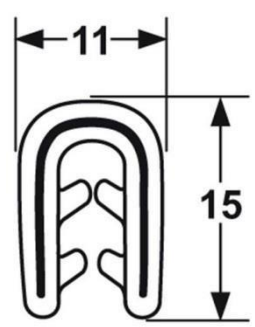

Grey Trim
66-176



Land Rover
39-499R

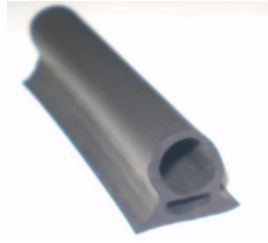

General Purpose
3610

UNIVERSAL AUTO SEALS

Made of Neoprene Sponge rubber. Hard wearing and durable closed cell sponge with a waterproof sealed surface. Used to seal car/boat Boots, Doors and hatches.

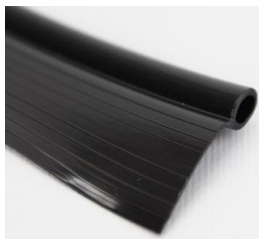

Fenderwelt 8mm
6174



Fenderwelt 5mm
10185

FENDERWELT PIPING

Made of black PVC, available in white upon request. For creating a bead/buffer around car fenders. Can also be used in upholstery and carpentry. Our piping is available in 2 diameters and the leg length is 20 and 25mm.

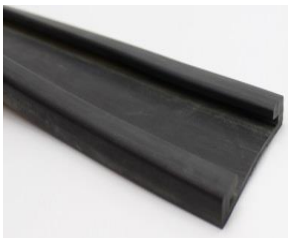

Tank Strap 38mm
3226

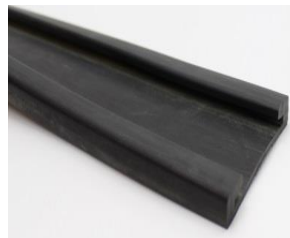

Tank Strap 50mm
3362

TANK STRAP

Our Nitrile rubber tank strap is ideal for use around petrol. Designed to create a buffer between a petrol tank and its support, our tank strap has hooked edges to prevent it from moving.



Flock
64-143



Flock
31-025

WINDOW FLOCKING

Felt lined rubber channel strip for lining roller window channels in automobiles. Designed to support the glass and provide a smooth surface for it to rub against.



Flock
64-067